



# Little helpers for veterinary medicine

Simple and smart

It's in your hands.  
Prevention of infection in veterinary medicine





**Information:**

More information about hygienic processes can be found here:  
[www.bbraun-vetcare.com/inyourhands](http://www.bbraun-vetcare.com/inyourhands)

This refers to advertising promoting the supply, sale, prescription, distribution or use of veterinary medicinal products.



This catalog shows only a small excerpt from our product portfolio. A wider choice can be found on our website:  
[www.bbraun-vetcare.de](http://www.bbraun-vetcare.de) and in our complete catalog



**Order complete catalog – Vet Care**

[www.bbraun-vetcare.com/ordercompletecatalog](http://www.bbraun-vetcare.com/ordercompletecatalog)



A female veterinarian with long brown hair tied back, wearing blue scrubs and a red stethoscope, is smiling warmly while holding a black and white speckled dog. The dog is standing on a blue examination table. The background shows a clean, clinical environment with light blue walls.

## Little helpers – big difference

Everyday life in the veterinary practice and clinic is often associated with stress. Patients need the best possible care. However, other tasks must also be completed in a timely manner.

Well-regulated and well-thought-out procedures help to create a smooth process.

B. Braun is in constant dialog with veterinarians and veterinary technicians and can develop products that support everyday tasks.

And these little things are often those that make a big difference. With the following selection of products, we would like to introduce you to our little helpers from our portfolio who can make everyday life easier and improve hygiene and safety.







## Care of hospitalized patients

VasoVet<sup>®</sup>, IntroVet<sup>®</sup>,  
Certofix<sup>®</sup>, Caresite<sup>®</sup>,  
Discofix<sup>®</sup> with Safe-  
flow, Softa<sup>®</sup> Swabs,  
SwabCap<sup>®</sup>, Defix<sup>®</sup>

# Caresite® Luer activated needleless connector

For all injections and infusions

## From practice

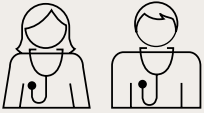

Do you know the problem? You take the patient off the infusion and after a short time there's blood in the extension or the catheter is clogged?

The automatic flushing function of the Caresite® valve during disconnection keeps positive pressure in the catheter, so that large amounts of blood cannot penetrate into the catheter.

Before the next connection, the valve can be easily disinfected and subsequently used again for administering medications.



Easy visual inspection



Simple disinfection



## Wrong

Here's an example without a Caresite® valve. Blood may be seen in the extension.

## Your benefits



Caresite® - explained briefly. Click here for the YouTube video

### Helps to avoid catheter occlusion

- Positive displacement feature prevents blood clots and catheter blockage

### Safe & hygienic handling

- Needle-free injection & aspiration
- Smooth surface allows thorough disinfection
- Transparent housing for good visual inspection
- Reduces contamination and provides an effective microbial barrier

### Easy to use

- Treatment pause possible



## Correct

The positive pressure of the occlusion prevents large amounts of blood from entering the catheter.

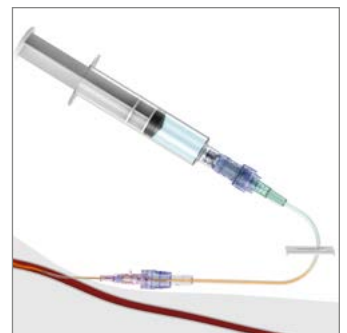

Caresite® is a closed system and reduces the risk of air embolism through the needle-free valve and helps to prevent external contamination (1-4).

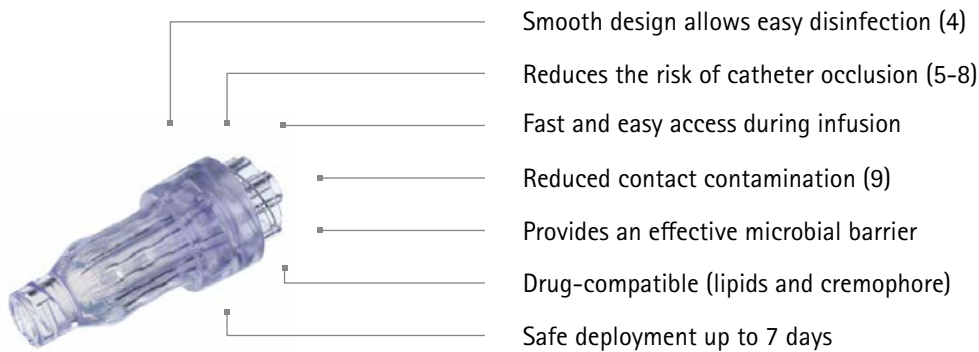

Type	Sales unit	Art. no.
Caresite®	10 pcs	41512201

#### References

- (1) Test report - Evaluation of the microbial barrier performance of the Caresite® valve against spores of Bacillus subtilis signed by Prof. Dr. med. M. Exner and Dr. rer. nat. J. Gebel, test report DMT 2013-412, 11.12.2013.
- (2) Test report - Closed system test by means of sodium fluorescein signed by Dr. rer. nat. J. Brünke Quality Labs BT GmbH Nuremberg, test report 1678.2-1, 28.05.2013
- (3) Test report - Evaluation of the microbial barrier performance of the female valve Caresite® by touch contamination with Staphylococcus aureus signed by Prof. Dr. med. M. Exner and Dr. rer. nat. J. Gebel, test report DMT 2014-194, 09.12.2014.
- (4) White Paper: Caresite® Luer Access Device (LAD): 7- Day Microbial Barrier Performance, B. Braun Medical Inc., Bethlehem, PA, 15-5669 SW, 2017.
- (5) Journal of Vascular Access Devices, Volume 5, Issue 4, 2000, Page 31-33, The effects of positive pressure devices on catheter occlusions, Loretta Berger RN, CRNI.
- (6) Leone M, Dillon R. Catheter outcomes in home infusion. JIN March/April 2008 Vol. 31, No. 2.
- (7) White Paper: Caresite® Luer Access Device: Blood Clearance Test of the Needleless Connector, B. Braun Medical Inc. Bethlehem, PA, CS05\_07/10\_EB. 2010.
- (8) White Paper: Caresite® Luer Access Device: Mechanical Hemolysis Test of the Needleless Connector, B. Braun Medical Inc., Bethlehem, PA., CS06\_07/10\_E8, 2010.
- (9) The ASAP Product Evaluation Program (PEP), Product Evaluation Program (PEP): Evaluation of Caresite® Luer Access Device, March 2016.

# Softa® Cloth CHX 2%

## Alcohol wipes

### From practice

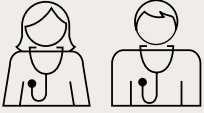

You are on the way to the ward and, as always, you don't have time: The catheter needs to be disinfected, but no disinfectant is available. Our individually packaged disinfectant wipes, the Softa® Cloth CHX 2%, fit into each gown bag and are thus always within reach.



### Description

- Single-use alcohol tissue with 2% Chlorhexidine gluconate (CHX)

### Properties

- Softa® Cloth 2% CHX disinfectant wipes for surfaces and medical devices
- Pack contents of 100

### Your benefits

- Single, especially compact packed
- Always on hand
- Hygienic, a new pad can be used for each process

Type	Sales unit	Art. no.
Softa® Cloth CHX 2%	100 pcs	19581

### Use cases:

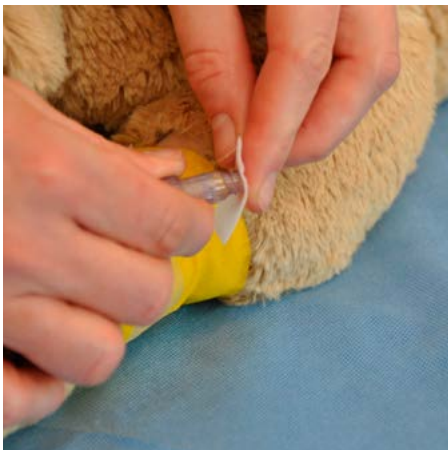

Disinfection of connectors and catheters  
e.g. VasoVet®, IntroVet®, Caresite®



Disinfection of multi-dose containers  
e.g. in combination with Mini-Spike® 2



# SwabCap®

For remarkable hygiene

## From practice

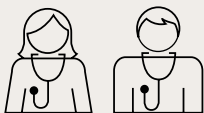

The patient will go for a walk or is temporarily disconnected from the infusion for the next treatment. During this time, the catheter may become contaminated by the environment. Therefore, re-disinfection prior to connection is necessary to avoid infection.

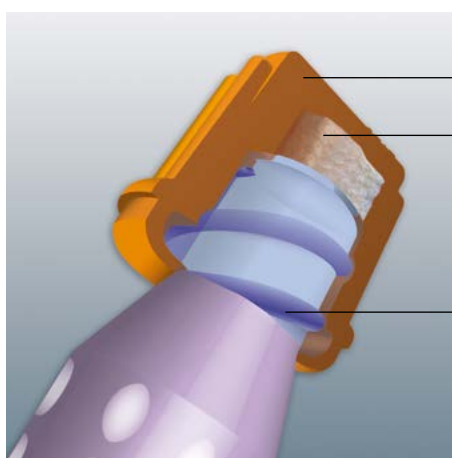

- Cap
- Non-particulate little sponge impregnated with 70% IPA
- Thread wrapped with 70% IPA

## Your benefits

- Protection against microbial contamination
- Simple disinfection technology for more time savings and process standardization
- Adequate support of in-hospital hygiene measures
- Rapid visual identification of the disinfected diaphragm valve
- Sterile packaging of SwabCap® for aseptic, contact-free connection to the membrane valve



The SwabCap® is a disinfecting cap with a particle-free sponge soaked in 70% isopropyl alcohol (IPA). It is used as a physical barrier to protect needle-free membrane valves and as a disinfectant cleaner designed to prevent microbial contamination.

For disinfection, the SwabCap® is screwed directly onto the respective membrane valve and can remain there for up to 7 days until the next use of the access. Complete disinfection of the membrane surface takes place within 5 minutes after the disinfection cap (1) has been screwed on. After disconnecting the SwabCap®, IV access can be used immediately.

Numerous studies confirm the effectiveness of the SwabCap® (2-8).

## References

- (1) Moreau N. Passive disinfection / Protection cap effectively disinfects swabbable luer access valves / needleless connectors. Poster session presented at the 2010 annual meeting of the Association for Vascular Access (AVA), National Harbor, MD.
- (2) Michelle DeVries et al., Reducing bloodstream infection risk in central and peripheral intravenous lines: initial data on passive intravenous connector disinfection. *Journal of Vascular Access*, Volume 19, No. 2: 87-93, 2014.
- (3) Marc-Oliver Wright MT (ASCP) et al., Continuous passive disinfection of catheter hubs prevents contamination and bloodstream infection. *American Journal of Infection Control*, Volume 41, No. 1: 33-38, 2013.
- (4) Cap the Connector: Save the Patient by Dr. Gregory Schears. Poster presented at AVA 2011, 25th Annual Scientific Meeting.
- (5) Use of disinfecting cap / flush syringe combination to address bloodstream infection and related issues by Hector Contreras. Poster presented at AVA 2012, Annual Scientific Meeting.
- (6) Integrated delivery system of disinfection cap and flush syringe, plus staff education, reduce bloodstream infections and treatment costs by Saungi McCalla. Poster presented at AVA 2012, Annual Scientific Meeting.
- (7) It takes a village to prevent central venous catheter infections and promote safety of patients by Barbara Bor. Poster presented at AVA 2012, Annual Scientific Meeting.
- (8) Improving IV connector disinfection by using human factors engineering to identify effective, nurse-friendly solutions by Patricia Rosa. Poster presented at APIC, 40th Annual Conference.

# SwabCap®

For remarkable hygiene



## Description

- SwabCap® disinfects needle-free membrane valves within 30 seconds after the connection and, unless the SwabCap® is removed, the disinfection of the valve surface is maintained for up to 7 days
- SwabCap® contains 70% isopropyl alcohol (IPA)
- SwabCap® is not a substitute for a combi-stopper cap
- SwabCap® can only be used in conjunction with needle-free diaphragm valves
- SwabCap® is also available in combination with the Omniflush® pre-filled syringe
- SwabCap® is for single use only

Type	Sales unit	Art. no.
SwabCap® disinfection cap with 70% isopropyl alcohol (IPA)	200 pcs	EM-SCXT3

## Use cases:



Simple attachment to the Caresite® valve



Hygienic closure until the next therapy

## Preparation for hygienic applications

### From practice

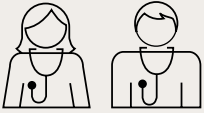

**Daily routine:** The preparation for the therapy of the patients in the ward must be ready in a timely manner and in compliance with strict hygiene measures. But how should the prepared medications be transported to the patients in the ward without contaminating them?

**The simple solution:** disposable kidney bowls. They can be prepared for one or more patients and are very suitable for hygienic transport to the patient.



### Your benefits

- Convenient: Individually removable
- Always on hand
- Hygienic: Use a new tray for each use

### Description

- Made of polystyrene
- 500 mL
- Contains 100 pcs per pack

Type	Sales unit	Art. no.
Defix®	100 pcs	5385200

### Use cases:



Preparing the medications and station accessories





# Medication preparation

Mini-Spike® 2, Sterifix®, Medibox®,  
Softasept® N



# Mini-Spike® 2

## Vented dispensing pin with swabable needle-free access valve

### From practice

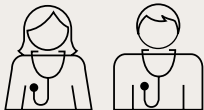

The multi-dose container has already been opened and the rubber stopper has been punctured several times with a needle. The closure is already slightly porous. The resulting problems may include:

- Particles from the cap may leak into the drug
- The surface can no longer be adequately disinfected
- Bacteria can contaminate the medication
- Fluid may leak: The concentration of the medication may change
- Fluid may leak out
- Needle must be used

The Mini-Spike® 2 can help to improve this process in a sustainable way: the spike is introduced into the vial. The removal is carried out needle-free through the disinfectable valve. The removal also works over the head without any drops. When the syringe is disconnected, the valve is automatically closed.

### Your benefits

- Available with various filters
- Easy to disinfect
- At least one bacteria retentive 0.45 µm air filter

### Description

With integral, needle-free valve Safeflow

- Simple disinfection of the exposed valve
- Opening of the valve when connecting a luer lock or luer plug syringe and automatic closing when disconnecting the used syringe
- Drop-free head removal through integral valve
- Helps to prevent leaks



### Mini-Spike® 2

- With integral, bacteria-proof 0.45 µm air filter

Type	Sales unit	Art. no.
Mini-Spike® 2	50 pcs	4550590



### Mini-Spike® 2 Filter

- With integral, bacteria-proof 0.45 µm air filter
- With integrated 5 µm particle filter that retains particles > 5 µm



Type	Sales unit	Art. no.
Mini-Spike® 2 Filter	50 pcs	4550591

### Mini-Spike® 2 Chemo

- With integrated bacteria-proof 0.2 µm air filter for protection against aerosols
- With integrated 5 µm particle filter that retains particles > 5 µm
- Extensive protection from toxic aerosols in the preparation of cytostatic solutions, reduced risk of contamination



Type	Sales unit	Art. no.
Mini-Spike® 2 Chemo	50 pcs	4550592

### Use cases:



Simple disinfection of the valve



Needle-free connection

# Mini-Spike® 2

## Hygiene in the multiple removal container

### Mini-Spike® 2

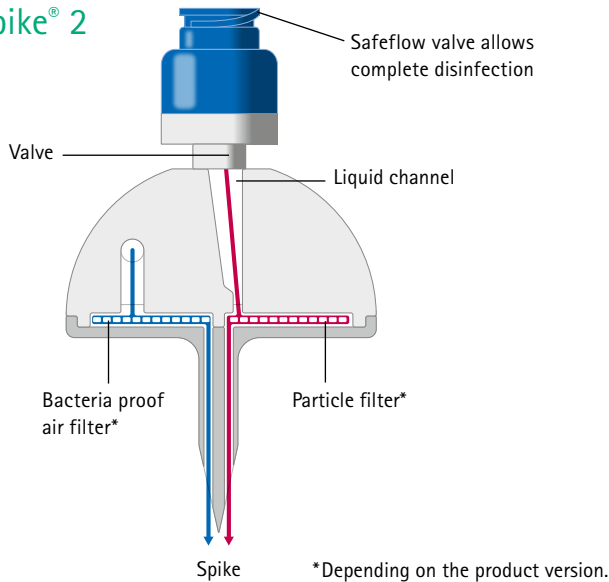

### Safeflow valve

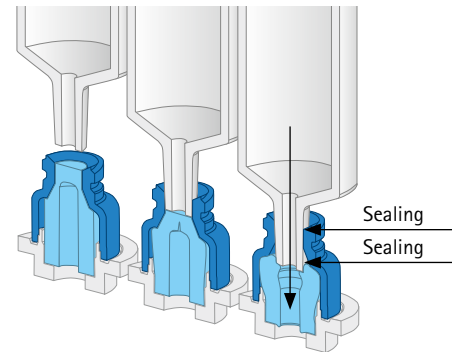

The Safeflow valve allows its easy disinfection. The needle-free valve opens when connected and automatically closes when disconnected. A fluid removal via the head is thus also possible here without any problems.

## Practical tip for the Mini-Spike® 2



1 Remove protective cap from vial, disinfect plug.

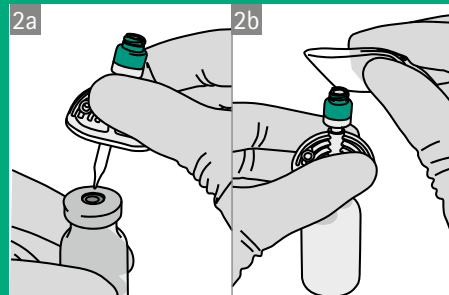

a) Remove the protective cap from the spike and insert the spike into the vial by holding the grip plate of the Mini-Spike® 2. Do not touch the female luer lock attachment on the Safeflow valve.

b) Disinfect the female luer lock with an impregnated disinfectant wipe or the disinfectant cap SwabCap®.

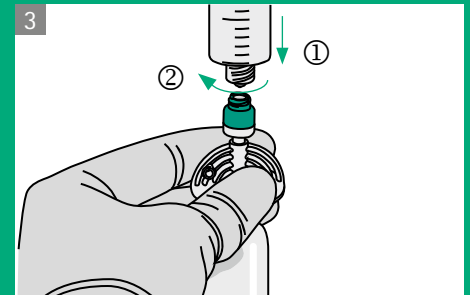

3 Connect the syringe to the female luer lock approach in the upright vial.

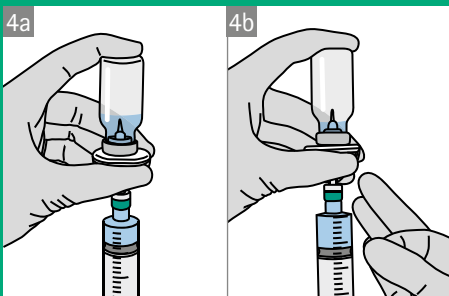

a) Turn the vial upside down and remove the solution.

b) To remove the air from the syringe, draw up half of the desired total volume and snap against the filled syringe. Push the plunger of the syringe to remove air from the syringe and then draw up the desired total volume.

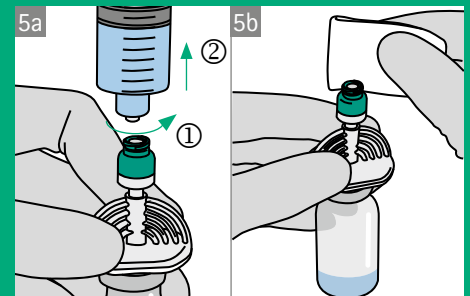

a) Disconnect the syringe from the female luer lock connector on the upright vial.

b) Disinfect the female luer lock with an impregnated disinfectant wipe or the disinfectant cap SwabCap®.

## 0.2 µm injection filter with luer lock extensions

### From practice

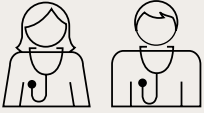

Special care must be taken in the treatment of intensive care patients. For central venous or epidural injections, special hygiene measures are required because bacteria and particles enter the bloodstream and central nervous system particularly rapidly. This poses a particular risk for immunosuppressed intensive care patients.

By inserting a Sterifix® filter, particles and bacteria can be filtered out before they reach the patient.



### Your benefits

- Bacterial and particles filters
- Protection of intensive care patients

### Description

- Injection and aspiration filter with integral 0.2 µm particle filter
- Not suitable for use with syringes < 10 mL
- For medication filtration during injection or aspiration
- Filter surface: polyethersulfone
- Remaining volume: 0.54 mL
- Pressure resistance: 5.2 bar

Type	Sales unit	Art. no.
Sterifix®	4 x 50 pcs	4099206



## Medical waste container for the disposal of medical sharps

### From practice

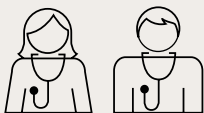

The injection has been done and the needle is firmly attached to the syringe. Now the needle must be discarded separately from the syringe. The Medibox® provides various openings for contactless disposal and thus protects the user. In addition, the Medibox® can be permanently closed, is break- and penetration-resistant.



### Your benefits

- Break-resistant and stable, puncture-resistant, irreversibly lockable
- Ergonomically designed for simplified handling
- Different openings for contactless disposal
- Good control of the maximum level at the side viewing window

### Description

- Complies with ISO 23907

**Complies with TRBA 250 waste container requirements**

**Medibox® sharps disposal containers are complying with international standard ISO 23907, ADR and 2008/68/EC**

Size	Sales unit	Art. no.
Medibox® 2.4 L	10 pcs	9193600
Medibox® 4.7 L	10 pcs	9193618
Medibox® 5.7 L	10 pcs	9193627
Medibox® 6.8 L	10 pcs	9193639
Medibox® 9.1 L	10 pcs	9193640

# Softasept® N

## Rapid skin disinfection before injections and punctures

### From practice

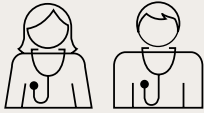

- Things have to happen quickly in everyday life and the patient must be prepared for its injection and the next treatment is due. This makes it all the more practical to have the disinfection ready for use.
- **Tip:** also available in the spray bottle – easy to spread and use.



### Your benefits

- Ready for use
- Exposure time from 15 sec

### Description

- Ready-to-use alcoholic skin disinfectant
- Short exposure time (from 15 seconds)
- Without microbicidal added active ingredients
- Active against bacteria (incl. MRSA, TbB) and fungi; limited virucide (incl. HBV, HCV, HIV) and active against rotaviruses and polioviruses
- Dries quickly
- DGHM/VAH listed
- Colorless
- Dyed on request

Delivery form	Sales unit	Art. no.
250 mL spray bottle	20 pcs	3887138



# Infusion therapy

Intrafix® SafeSet, Sterifix®,  
Mini-Plasco® Connect, Ecoflac®



# Intrafix® SafeSet

## Premium IV-Administration Set with AirStop and PrimeStop

### From practice

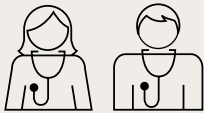

The infusion line is empty, there is air in the system. A critical situation for the patient. An air embolism is imminent. All lines must now be drained as quickly as possible or a new system must be connected.

With Intrafix® SafeSet you help to prevent these problems.



Intrafix® SafeSet - explained briefly. Click here for the YouTube video



### Your benefits

- Protection against air infusions (AirStop) and automatic line bleeding without loss of fluid (PrimeStop)
- AirStop: The filter membrane acts as a barrier, preventing air from entering the connecting line
- PrimeStop: The protective cap with integrated, liquid-repellent membrane prevents the leaking of infusion solutions
- Sharp piercing mandrel for easy piercing even into suspended containers
- Bacteria-proof ventilation with closure flap

### Description

- Chamber with highly transparent dome design. Good to see drop forming
- Particle filter 15 µm
- Pressure resistance up to 2 bar and suitable for use with infusion pumps designed for a 3 x 4.1 mm tubing
- Latex- and DEHP-free, Neutrapur: PVC-free
- Luer lock approach connector

Type / hose length	Sales unit	Art. no.
Standard, 180 cm	100 pcs	4063000
B. C. V., 180 cm, with check valve	1 pc	4063001
Standard, 230 cm	100 pcs	4063003
Intrafix® SafeSet, Y-Caresite®, needle-free injection valve	10 pcs	4063004C
3-W. S. C., 200 + 20 cm, with three-way stopcock Discofix® C	100 pcs	4063006
UV-protect, orange-transparent, 180 cm, PVC-free*	1 pc	4063131

\* Not for use with pressure infusion sets, only with pressure cuffs



## Infusion filter

### From practice

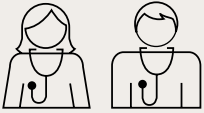

The infusion is running, the closure has been contaminated, and bacteria are released into the bloodstream. This can be a problem, especially in intensive care patients.

By inserting a Sterifix® filter, particles and bacteria can be filtered out before they harm the patient.

### Your benefits

- Bacterial, particle and fungal retention
- Position-independent air separation
- Elimination of air

### Description

- Uncharged 0.2 µm polyethersulfone filter membrane
- Low protein binding capacity
- Filter area: 10 cm<sup>2</sup>
- Flow rate (distilled water): > 30 mL/min
- Pressure resistance: 2 bar
- Recommended service life: up to 24 h
- With luer lock approaches
- Not made with latex and DEHP



Type	Sales unit	Art. no.
Sterifix® Neonate	50 pcs	4099257
Sterifix® Paed	50 pcs	4099354
Sterifix®	50 pcs	4099303
Sterifix® (PVC-free)	50 pcs	4184637

# Discofix® C with Safeflow

## Stopcock system

### From practice

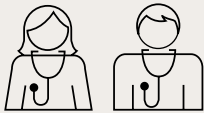

Do you know the situation? The central venous catheter is in place. A three-way stopcock is practical: Infusion may be continuous, and medications may be given concurrently. The problem: normal three-way stopcocks are difficult to disinfect.

The Discofix® three-way stopcock with Safeflow comes with a valve that is easy to disinfect.

### Discofix® C with Safeflow



### Your benefits

- Combines the benefits of Discofix® C and Safeflow
- The tight-closing Safeflow membrane eliminates the need for protective caps

### Description

- Closed system, medication-resistant system
- Reliable connection by rotating the three-way stopcock around its own axis
- Light snap at every 45° turn on the handle
- The smooth surface of the Safeflow allows an efficient disinfection for hygienic work

Color	Sales unit	Art. no.
Blue	100 pcs	16494CSF

### Discofix® C with Safeflow and extension line



Color	Conduction	Ø outside	Ø inside	Sales unit	Art. no.
Blue	10 cm	4.1 mm	2.5 mm	50 pcs	16500CSF
Blue	25 cm	4.1 mm	2.5 mm	50 pcs	16520CSF
Blue	50 cm	4.1 mm	2.5 mm	50 pcs	16540CSF
Blue	75 cm	4.1 mm	2.5 mm	50 pcs	16551CSF
Blue	100 cm	4.1 mm	2.5 mm	50 pcs	16560CSF

# Mini-Plasco® Connect

## Safety for humans and animals

### From practice

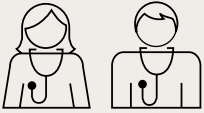

You cut your finger again and the medication is contaminated with glass splinters. Unfortunately, this happens more often in everyday life.

**Tip:** Mini-Plasco® Connect is available for various solutions in practical, small, ready-to-use packages.



### Your benefits

- Single packaged
- Small volumes for hygienic use

# Ecoflac® plus

A container that satisfies and pays for itself



Ecoflac® plus helps to reduce the risk of contamination and therefore increases patient and user safety.

## Your benefits

From preparing the medicines to administering them – the Ecoflac® plus satisfies owing to the following advantages:

- Proven closed system with the B. Braun infusion set Intrafix® SafeSet reduces potential microbial contamination
- Capacity of the reservoir to collapse during infusion; no ventilation required
- DEHP-, PVC- and latex-free
- Stable, non-slip and unbreakable, as no glass is used
- Standing or horizontal storage possible
- Easy handling due to the integrated suspension

## Container head

- Two germ-free puncture sites: no disinfection of the stopper is required immediately after opening
- Reclosable port elements of the container head prevent the penetration of germs into the container and the leakage of the infusion solution

The Ecoflac® plus contains no stabilizers or plasticizers. Therefore, it does not tend to adsorb or precipitate added medications or to migrate the material into the solution.

## This means:

**A high level of medication safety through Ecoflac® plus.**

## Correct reading of the infusion volume

- When using infusion lines that keep venting closed
- When the bottle is full, the water level is higher than the scale
- Ecoflac® Plus bottle gradually contracts
- The scale changes to reflect the current amount of fluid
- The scale shows how much fluid has been infused when emptied



Ecoflac® full



Ecoflac® emptied







A person wearing blue scrubs is shown from the side, putting on a blue nitrile glove on their left hand. The background is a clinical setting with a white table and a lamp. A green rectangular graphic element is in the top left corner.

## Little helpers – for all daily tasks

Softa-Man® pure, Softasept® N,  
Vasco® Nitril sky-blue, Vasco® OP Grip

# Softa-Man<sup>®</sup> pure

## Dye- and perfume-free hand disinfection

### From practice

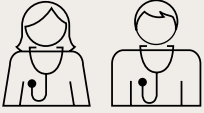

- Occupationally stressed hands tend to have invisible to visible injuries. An alcoholic disinfectant may cause pain during use. Softa-Man<sup>®</sup> pure returns care to your hands every time it is used.
- **Tip:** is also available in the practical 100 mL gown bottle and is therefore always with you, even if there is no dispenser nearby.



### Your benefits

- Especially for very sensitive skin
- Colorless and perfume-free
- Free of added active ingredients

### Description

- Low allergen hand sanitizer
- DGHM/VAH listed and in the IHO disinfectant list
- Effective against bacteria (including MRSA, TbB) and fungi
- Viral efficacy: limited virucide (including HBV, HCV, HIV), effective against rotaviruses and influenza viruses
- Colorless and perfume-free
- Free of added active ingredients
- Especially for very sensitive skin
- Care with panthenol (provitamin B5), bisabolol and allantoin
- Exposure time for hygienic hand disinfection: 30 sec
- Exposure time for surgical hand disinfection: 60 sec

Delivery form	Sales unit	Art. no.
100 mL bottle	20 pcs	19152
500 mL dispenser	20 pcs	19153
1000 mL dispenser bottle	10 pcs	19154

# Softasept® N

Ready-to use skin disinfection before injections and venous punctures

## From practice

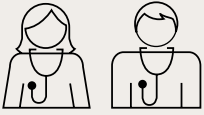

- Acting fast is part of daily routine, and the patient must be prepared for its injection and the next treatment is due. This makes it all the more practical to have the disinfection ready for use.
- **Tip:** also available in the spray bottle – easy to distribute and use.



## Your benefits

- Ready for use
- Exposure time from 15 sec

## Description

- Ready-to-use alcoholic skin disinfectant
- Short exposure time (from 15 seconds)
- Without microbicidal added active ingredients
- Active against bacteria (incl. MRSA, TbB) and fungi; limited virucide (incl. HBV, HCV, HIV) and active against rotaviruses and polioviruses
- Dries quickly
- DGHM/VAH listed
- Colorless
- Dyed on request

Delivery form	Sales unit	Art. no.
250 mL spray bottle	20 pcs	Ask your local contact
1000 mL bottle	10 pcs	Ask your local contact
5 Liter canister	1 canister	Ask your local contact

# Vasco® Nitril sky-blue

## Non-sterile examination gloves

### From practice

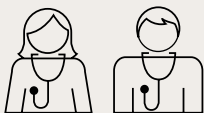

You know that?

You put on the gloves briefly for the next examination and the glove tears. That's annoying.

Vasco® Nitril sky-blue offers good properties for daily use in veterinary practice and clinic.



### Your benefits

- Barrier properties: Stable against certain medications and chemicals (more details can be found on the respective technical data sheets)
- Resistant to viruses and bacteria

### Description

- Unsterile nitrile examination glove with rolling edge, 240 mm
- Powder-free, latex-free, thiuram-free
- Medical device Class I according to Medical Device Regulation (EU) 2017/745
- Personal protective equipment category III CE 2777 (SATRA) according to PPER (EU) 2016/425
- AQL: < 1.5

Delivery form	Sales unit	Art. no.
XS	100 pcs	9203902
S	100 pcs	9203910
M	100 pcs	9203929
L	100 pcs	9203937
XL	100 pcs	9203945

Lieferform	Sales unit	Art. no.
XS	150 pcs	9206502
S	150 pcs	9206510
M	150 pcs	9206529
L	150 pcs	9206537
XL	135 pcs	9206545



# Vasco® OP Grip

## Sterile surgical gloves with the special hold

### From practice

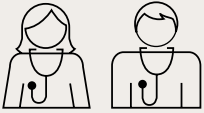

Do you ever lack of finger touch?

Surgical gloves protect the patient and medical staff. Sometimes the feeling and grip with surgical gloves is not enough.

Vasco® OP Grip have a structured surface in the finger area and thus ensure a good hold during surgery and aseptic activities.



### Your benefits

- Special texturing on the fingers for optimal hold
- For a good hold and a tactile feeling
- Very good tensile strength

### Description

- Sterile, naturally white latex surgical gloves with rolling edge
- Medical surgical glove according to MDD 93/42/EEC (Class IIa)
- Protective glove according to PPE Regulation (EU) 2016/425 (Cat. III)
- Powder-free
- Excellent grip
- AQL: 0.65

Delivery form	Sales unit	Art. no.
5.5	40 pairs	6081409
6	40 pairs	6081417
6.5	40 pairs	6081425
7	40 pairs	6081433
7.5	40 pairs	6081441
8	40 pairs	6081450
8.5	40 pairs	6081468
9	40 pairs	6081476

# Mandatory texts

## **Softa-Man®/Softa-Man® acute/Softa-Man® pure/ Softa-Man® ViscoRub**

**Composition:** 100 mL solution contains: Active ingredients: ethanol (100%) 45 g, 1-propanol (Ph. Eur.) 18 g; excipients: Softa-Man®: purified water, diisopropyladipate, macrogol-6-glycerol caprylocaprate, dexpanthenol, (+/-)alpha-bisabolol, odors (containing limonene and linalool), allantoin. Softa-Man® acute: purified water, macrogol 4000, butan-2-one, octyldodecanol (Ph. Eur.), glycerol, phosphoric acid 85%. Softa-Man® pure: purified water, isopropyl myristate (Ph. Eur.), octyldodecanol (Ph. Eur.), dexpanthenol, glycerol, (+/-)alpha-bisabolol,

allantoin, denatonium benzoate. Softa-Man® ViscoRub: purified water, butan-2-one, glycerol, isopropyl myristate (Ph. Eur.), (hexadecyl, octadecyl)[(RS)-2-ethylhexanoate], octyldodecanol (Ph. Eur.), edetol, acrylates (C10-30 alkyl acrylate crosspolymer), (+/-)alpha-bisabolol.

**Applications:** Hygienic and surgical hand disinfection.

**Contraindications:** Hypersensitivity (allergy) to ethanol or 1-propanol or to any of the excipients.

**Side effects:** contact allergy. Skin irritations such as redness and burning especially with frequent use.

**Warnings:** Flammable. Keep container tightly closed. Keep away from ignition sources. Don't smoke! Don't get it in your eyes. Do not apply to injured skin or mucous membranes. For external use only.

52.3% by weight of ethanol

20.9% by weight of 1-propanol

21 °C flashpoint according to DIN 51 755

**Information last updated:** 02/2012

**Pharmaceutical entrepreneur:**

B. Braun Melsungen AG

34209 Melsungen

## **Softasept® N/Softasept® N dyed**

**Composition:** 100 g solution contains: Pharmaceutically active ingredients: ethanol (100%) 74.1 g, 2-propanol (Ph. Eur.) 10.0 g; excipients: purified water (Softasept® N additionally stains povidone K 30, citric acid, sunset yellow FCF (E 110) and azorubine (E 122)).

**Therapeutic indications:** skin disinfection prior to surgery, puncture and injection.

**Contraindications:** Hypersensitivity (allergy) to ethanol, 2-propanol or (only Softasept® N dyed) any of the excipients. Softasept® N is not suitable for the antiseptics

of mucous membranes and for use in the immediate vicinity of the eyes.

**Side effects:** Skin irritations such as redness and burning may occur, especially with frequent use. Contact allergies are also possible.

**Warnings:** Slightly flammable. Keep container tightly closed. Keep away from ignition sources. Don't smoke! Do not spray in an open flame. Don't get it in your eyes. Do not apply to injured skin or mucous membranes. For external use only. Flame point of 14 °C according to DIN 51755.

**Information last updated:** 03/2011

**Pharmaceutical entrepreneur:**

B. Braun Melsungen AG

34209 Melsungen



B. Braun Vet Care GmbH | Am Aesculap-Platz | 78532 Tuttlingen | [info@bbraun-vetcare.de](mailto:info@bbraun-vetcare.de) | [www.bbraun-vetcare.com](http://www.bbraun-vetcare.com)

Thank you very much - the pictures were taken in Hergolding with the kind support of the small animal specialist Frontier GmbH.

The product brands "Caresite", "Certofix", "Defix", "Discofix", "Ecoflac", "Intrafix", "IntroVet", "Medibox", "Mini-Plasco", "Mini-Spike", "Softa-Man", "Softasept", "Sterifix", "SwabCap", "Vasco" and "VasoVet" are registered trademarks of B. Braun Melsungen AG. Subject to technical modifications. This brochure may only be used to provide information about our products. Reproduction, in whole or in part, is prohibited.